

MULTIPANEL Internal Wet Area Waterproofing System

Installation
guide

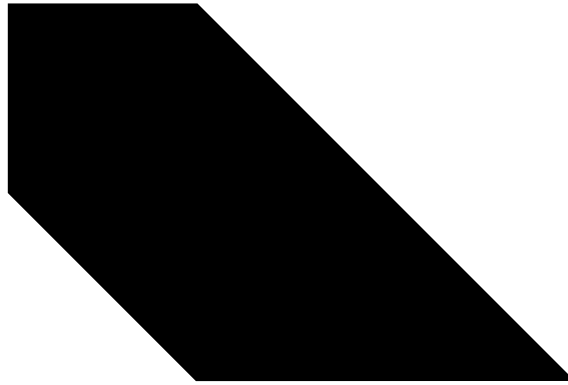

MULTIPANEL

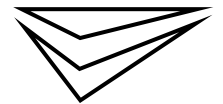

Product information

THICKNESS	PRODUCT CODE	SIZE (MM)	WEIGHT PER SHEET
8mm	MP08	2400 × 1200	5.2Kg
12mm	MP12	2400 × 1200	7.2Kg



Showerbase sizes

SIZE	WASTE OUTLET / GRATE SIZE
900 × 900 × 25mm (1:80 min.fall)	Centre/NA
1200 × 900 × 25mm (1:80 min.fall)	Centre/NA
Custom* (1:80 min.fall)	TBA



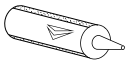

	LINEAR GRATE SIZES	DESCRIPTION
1200 × 900 × 25mm (1:80 min.fall)	900 × 55–70 × 20–25mm (L,W,H)	Centre of grate is positioned 190mm from the frame. Refer to Step 12 of Shower Base Kit Installation.
1500 × 900 × 25mm (1:80 min.fall)	1200 × 55–70 × 20–25mm (L,W,H)	
1800 × 900 × 25mm (1:80 min.fall)	1500 × 55–70 × 20–25mm (L,W,H)	

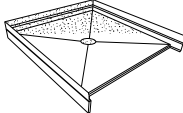
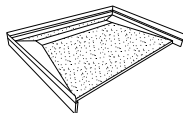
*Custom sizes up to 2400 × 1200mm are available. Refer to Custom Order Form available at www.multipanel.com.au for full terms and conditions.

Accessories/components supplied by MULTIPANEL

COMPONENT	DESCRIPTION
MULTIPANEL FOAMING Adhesive 	PU Foaming adhesive. 310ml. Colour: Opaque
MULTIPANEL SEALANT Adhesive 	PU Sealant adhesive. 600ml. Colour: Grey
MULTIPANEL Shower Base kit 	<ul style="list-style-type: none"> / Pre formed shower base / Upstands × 3 / 50mm Stainless Steel z flashings / Gloves / Blade / MP FOAMING Adhesive / MP SEALANT Adhesive
MULTIPANEL Linear Shower Base kit 	<ul style="list-style-type: none"> / Pre formed shower base / Upstands × 3 / 50mm Stainless Steel z flashings / Gloves / Blade / FMP100 adhesive / FIX30 sealant adhesive

Product accessories/components not supplied by MULTIPANEL

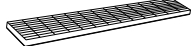
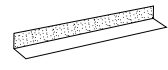
COMPONENT	DESCRIPTION
Screws 	For fixing into timber frame, use either a galvanized or min class 3 screw. Refer to manufactures for suitability
Nails 	For fixing into timber frame, use either a galvanized or min class 3 nail. Refer to manufactures for suitability
Blade 	For spreading adhesive over all sheet joints and fixings.
Gloves 	Recommended when using adhesive.
Linear Grate System 	Select grate to suit your tile thickness.
	Stainless Steel corner angle or a compatible material to comply with AS3740 waterproof material.

What is MULTIPANEL?

MULTIPANEL manufactures a revolutionary, high-density, polyurethane composite building panel, ideal for waterproofing bathrooms and wet areas as it is lightweight, 100% waterproof, highly versatile and replaces the need for a liquid membrane.

This innovative product is currently the most technologically advanced construction panel on the global market. It is a significantly superior alternate to traditional building materials.

Product advantages

/ Lightweight

/ 100% waterproof

/ Eco-Friendly

/ Labour Saving

/ Insulating

NO MEMBRANE REQUIRED

CODEMARK Certification

The MULTIPANEL Internal Wet Area Waterproofing System is CODEMARK certified

For more information please visit www.multipanel.com.au



Certificate CM20270 Rev 2

Safety

MULTIPANEL is an inert, non-toxic, non-carcinogenic material and is not considered harmful, however inhalation of dust produced during cutting should be avoided.

Eye, ear and mouth protection should be worn whenever cutting or sanding MULTIPANEL.

Gloves are recommended when applying adhesives. Uncured adhesive may be removed from tools, timber and tiles with alcohol cleaner such as Methylated spirits. Cured adhesive must be removed mechanically.

A and B surfaces of MULTIPANEL

During the manufacturing process some air pockets may form. These air bubbles are small in size and appear on the "B" side of the panel only. Every panel produced is stamped to advise the "B" side. Holes will not compromise the integrity or waterproofing of the system. When installing MULTIPANEL, ensure the "A" side of the panel is placed face up.

Cutting

Standard woodworking tools can be used for all cutting of MULTIPANEL.

Storage and handling

MULTIPANEL should always be stored flat, on a level surface, and away from direct sunlight. UV light will cause discolouration of MULTIPANEL however will not change the structural integrity.

Adhesion

The MULTIPANEL adhesives listed on page 1, must be used in conjunction with mechanical fixing, when gluing panels to substrate.

Design considerations

Framing

TIMBER FRAMING

Timber framing must be in accordance with AS 1684 - 'Residential timber-framed construction', the building code of Australia and the framing manufacturer's specifications.

Adequate ventilation of the subfloor must be in accordance with the National Construction Code.

STEEL FRAMING

Steel framing must be in accordance with AS 3623 - 'Domestic metal framing' and the framing manufacturer's specifications.

TOLERANCES

Framing must be straight and true. Framing tolerances must comply with relevant codes and manufacturer's specifications.

Design

COMPLIANCE

All design and construction must comply with the appropriate requirements of the current Building Code of Australia (BCA) and other applicable regulations and standards current at the time of construction.

Tiling

Install tiles as per AS 3958.1-2007. When tiling, please ensure a compatible polyurethane tile adhesive is used. For a list of recommended adhesives visit www.multipanel.com.au or call MULTIPANEL on (03) 9787 2544.

MULTIPANEL



Shower base kit installation

This guide will provide instructions on three common installation methods, Step Up, Walk In and Linear Base as shown on page 3. The shower base is preformed with a graded fall. 75mm vertical up-stands are provided to form the junction between the base and adjoining walls. These up-stands are cut and installed on-site creating a waterproof floor and wall installation.

Step 1

Prepare substrate according to preference, as per diagrams on page 3.

NOTE — Ensure surface is flat and free of dust and Debris.

Step 2

Put the base in place, check it is square and true, if not, trim base to suit application. (Trim base using traditional woodworking tools)

Step 3

Remove base and fix MULTIPANEL upstands to base with a continuous 3mm bead of MP FOAMING Adhesive along the groove and screw or nail off at 150mm centres using a minimum 25mm x 2.8mm screw or nail.

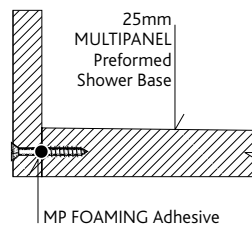

Step 4

Apply a 6mm bead of MP FOAMING adhesive in a 200 x 200mm grid pattern.

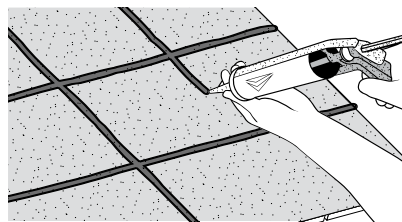

Step 5

Seal the puddle flange to the underside of the shower base, using a continuous bead of MP SEALANT Adhesive and embed the base onto the puddle flange.

NOTE — Puddle flange must be rebated into subfloor to finish flush.

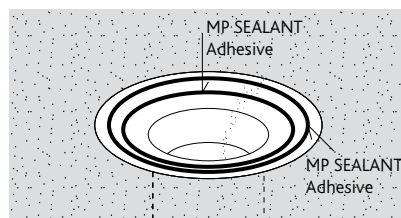

Step 6

Fit base into place and screw or nail off at 300mm centres

Step 7

Notch metal flashing for internal corner matching.

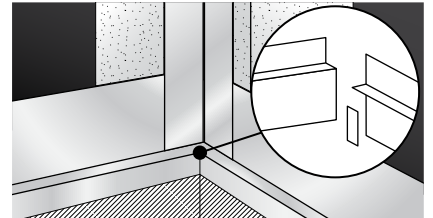

Step 8

Install the metal flashings supplied by MULTIPANEL in the Shower Base Kit, and nail off using a 30mm x 2.8mm nail.

NOTE — Stainless Steel flashing will need to be drilled prior to fixing.

Step 9

Apply a continuous 3mm bead of MP SEALANT Adhesive to upstand junctions.

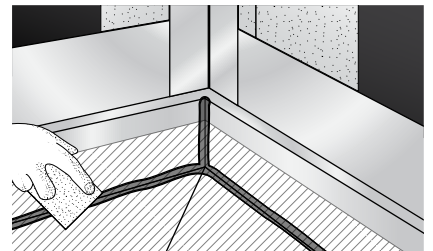

Step 10

Apply MP SEALANT Adhesive over heads of fixings over base and blade off.

NOTE — To ensure a complete waterproof bathroom solution, 8mm MULTIPANEL underlay and 12mm MULTIPANEL Wall Lining must be installed in accordance with the MULTIPANEL Underlay and MULTIPANEL Wall Lining Installation Steps.

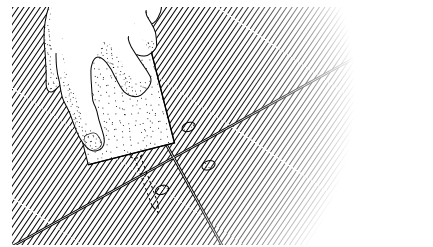

Step 11

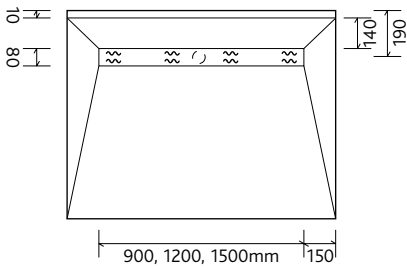

Glue in grate using MP SEALANT Adhesive spot glue to allow moisture to enter outlet.

Step 12

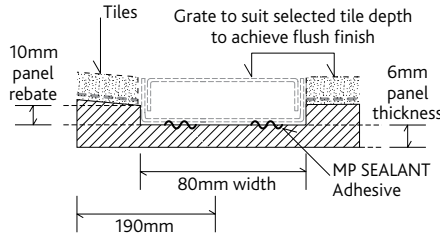

Embed the lineal grate system into MULTIPANEL cut out, using MP SEALANT Adhesive sealant to spot glue grate in position.
NOTE — Centre of grate is positioned 190mm from frame.

Waterproof membrane over MULTIPANEL is not required

STEP UP — DIAGRAM 1

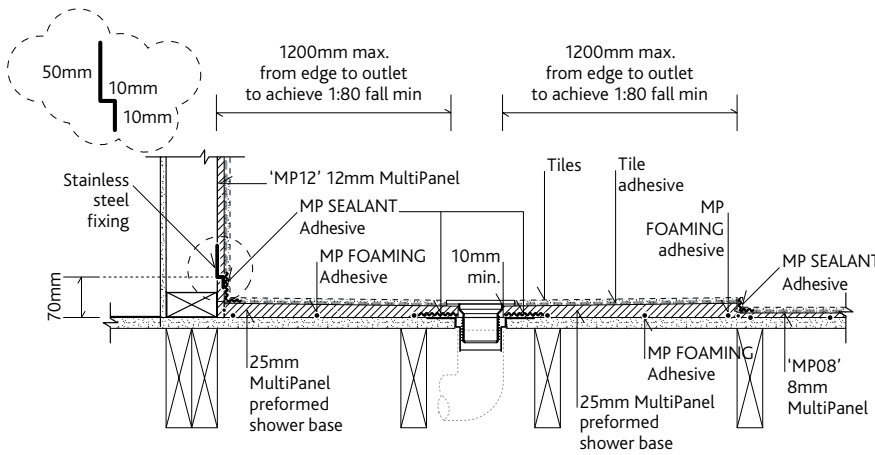

WALK IN — DIAGRAM 2

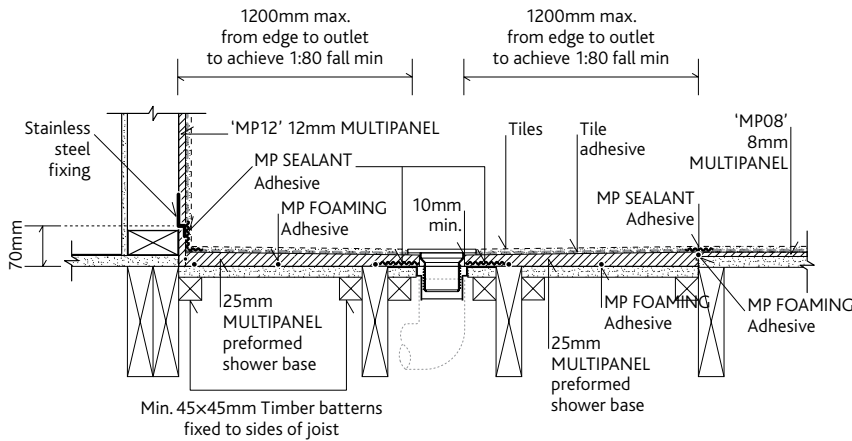

LINEAR BASE — DIAGRAM 3

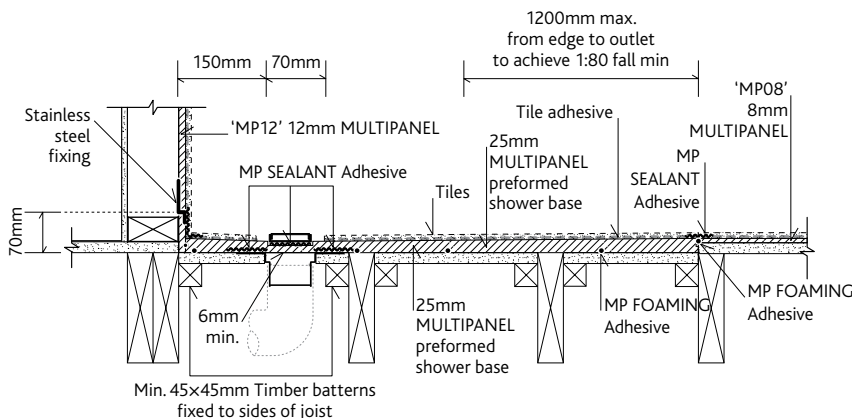

MULTIPANEL wall lining installation

Step 1

Trim out wall to support MULTIPANEL on all edges. Studs at maximum 300mm centres. Install standard corner flashings. Apply MP FOAMING Adhesive in a single continuous bead to the stud and noggins framework.

Step 2

Fix minimum 12mm MULTIPANEL onto framework at 300mm centres, 200mm around perimeter and 20mm from panel edge.
NOTE — MULTIPANEL can be used in curved walls, contact MULTIPANEL for further information.

Step 3

Place continuous bead of MP FOAMING Adhesive along panel edge of sheet in position.

Place second sheet of 12mm MULTIPANEL so that the panel edge butts up against sheet. Blade off excess MP FOAMING Adhesive.
NOTE — Allow 3 hours for the MP FOAMING adhesive to cure.

Apply a continuous bead of MP SEALANT Adhesive as shown in Figure 2 below and blade off creating a 50mm band over the join of the two sheets.

Step 4

Apply MP SEALANT Adhesive over the heads of fixings and all sheet joints and junctions to achieve waterproofing. Blade off excess adhesive.

Step 5

Where MULTIPANEL meets plasterboard, use standard plastering techniques. Surface is now ready for finishing. Contact MULTIPANEL for specific painting requirements.

NOTE — For best results bevel edge of MULTIPANEL to match plasterboard.

Step 6

Any wall penetrations, including shower breaches and tap outlets are to be sealed using MP SEALANT Adhesive.

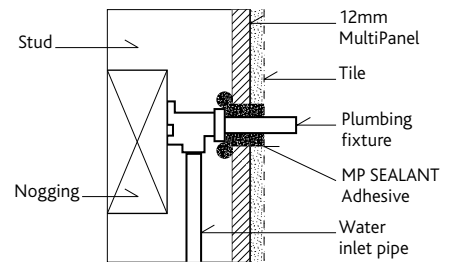

Figure 1 — Detail of sealing wall penetration
NOTE — Apply a continuous bead of MP SEALANT Adhesive to all corner and vertical flashings.

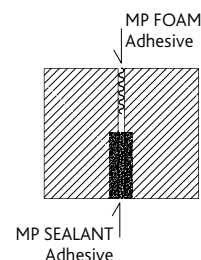

Figure 2 — Detail of sealing sheet joints

MULTIPANEL UNDERLAY INSTALLATION
REFER TO PAGE 4

CONCRETE SET DOWN

Step 1

Trowel in relevant tile adhesive into shower base set down and build up to achieve level surface.

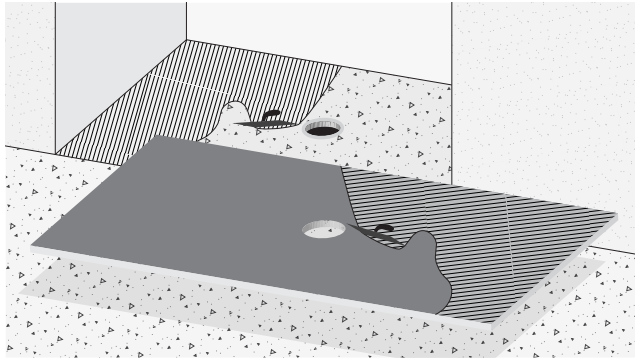

Step 1

Place base into rebate and fit into adhesive ensuring the base remains level. Apply weight evenly across the base while adhesive cures.

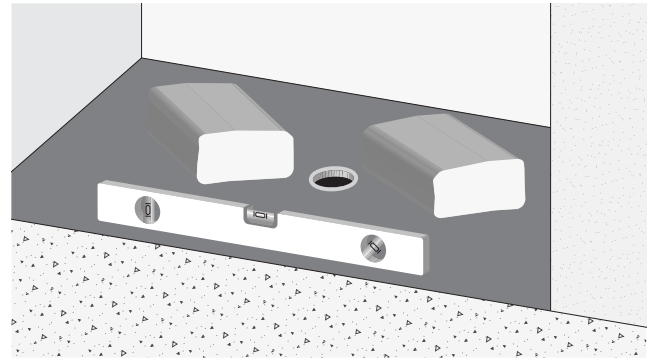

For a list of recommended tile adhesives, visit multipanel.com.au

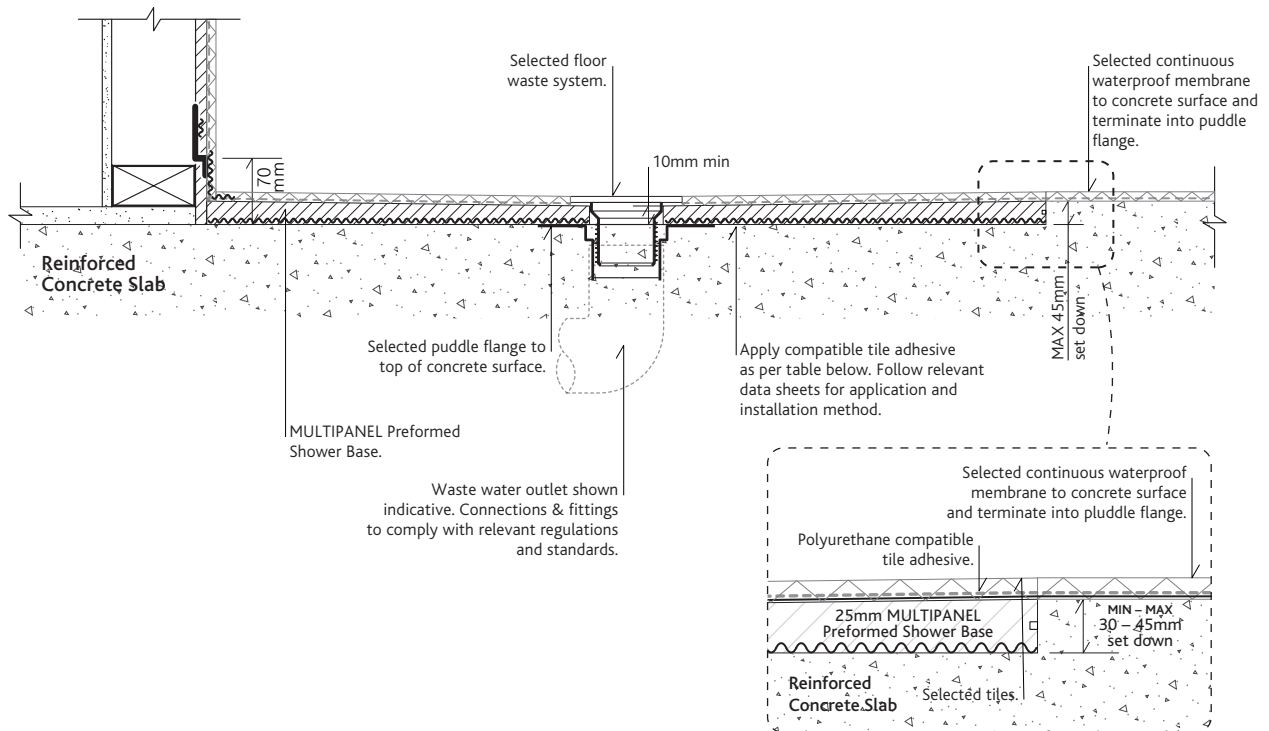

MULTIPANEL underlay installation

Step 1

Prepare substrate flooring ready for MULTIPANEL Waterproof Underlay. For use in wet areas over an accepted substrate (installed to Australian Standards).

NOTE — Ensure floor substrate is sound, flat and dust free prior to installing MULTIPANEL Waterproof Underlay.

Step 2

Apply MP FOAMING Adhesive to substrate flooring in continuous 3mm bead, spacing 100mm apart.

Step 3

Lay minimum 8mm MULTIPANEL to substrate flooring, fixing off at 300mm centres, 200mm around perimeter and 20mm from panel edge.

NOTE — When gluing the sheets together, apply a continuous 3mm bead of MP FOAMING Adhesive along the sheet edges and butt joint.

Step 4

Blade off excess adhesive over the joints. Allow MP FOAMING Adhesive three (3) hours to cure.

NOTE — This process needs to be repeated 2-3 times until the MP FOAMING Adhesive has finished expanding.

Step 5

Apply MP SEALANT Adhesive over the heads of fixings and sheet joints. Blade off excess sealant.

NOTE — Surface is now ready for finishing, waterproof membrane over MULTIPANEL is not required.

MULTIPANEL waterproof bathroom detail guide

MULTIPANEL OPTION — NO MEMBRANE REQUIRED

NOTE — Metal flashings and corner angles are installed prior to the installation of the MULTIPANEL internal wall lining.

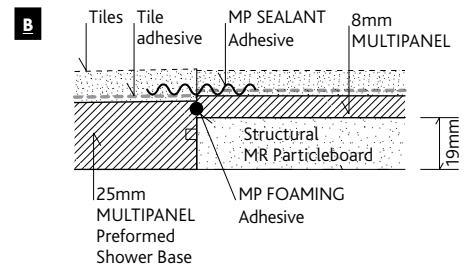
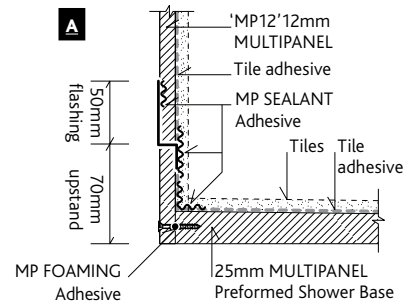
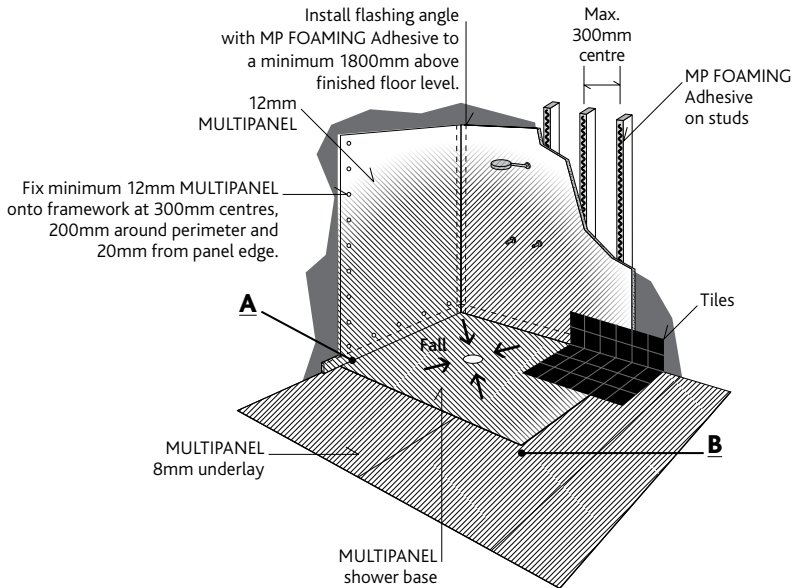

ALTERNATE OPTION — MEMBRANE REQUIRED

NOTE — Metal flashings and corner angles are installed prior to the installation of the MULTIPANEL internal wall lining. When using an alternate membrane, it must comply with AS 3740, the manufactures requirements, and any other relevant standards.

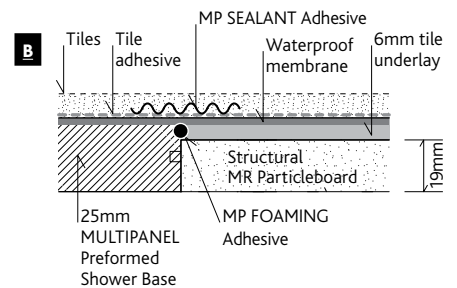
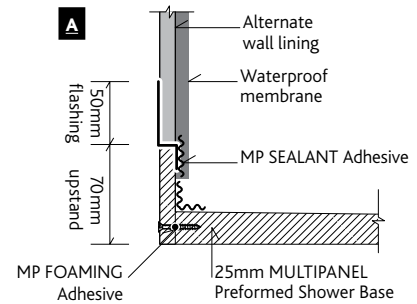
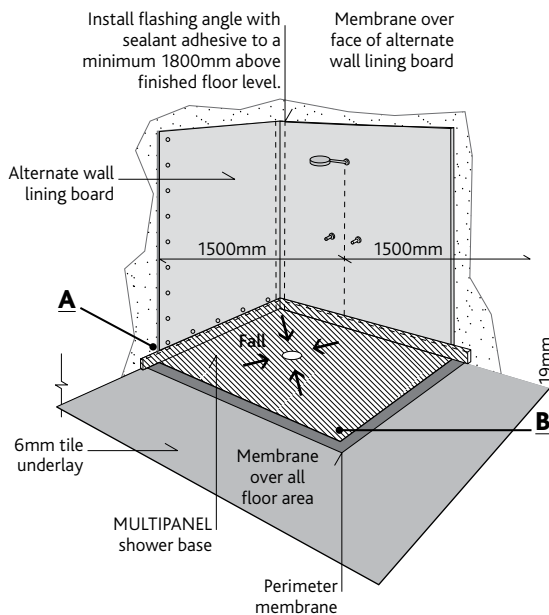

Warranty and conditions

The company warrants the MULTIPANEL Internal Wet Area Waterproofing System ("the product") for period of (10) years ("the warranty period") from the date of purchase, that it will be free from defects due to faulty manufacturing, and will be resistant to cracking, rotting, water, fire, and damage to the extent set out in the relevant MULTIPANEL published literature, and subject to compliance to the conditions set out below.

Conditions of warranty

The warranty is strictly subject to the following conditions (which are in addition to and do not displace the MULTIPANEL Terms and Conditions of Sale).

- a. The product and any other components of the system must be installed in accordance with the relevant MULTIPANEL literature current at the time of installation. Further to all other products including jointing and sealing systems, that are applied or used in conjunction with the product must be installed as per the relevant manufacturer's specifications at the time of installation.
- b. MULTIPANEL will not be liable for, and will not accept any breach of Warranty claims, unless the claimant provides proof of purchase within 30 days of the alleged defect becoming apparent.
- c. Under no circumstances is the Warranty transferable.
- d. MULTIPANEL will not be liable for defects arising from materials and components not supplied by MULTIPANEL, or the use of goods by a person in a manner not consistent with the recommendations made by MULTIPANEL.
- e. A claimant's sole remedy for breach of Warranty is (at the company's option) that MULTIPANEL will repair or replace the defect, pay the cost of replacement or rectification of the affected product, or supply replacement product.
- f. Under no circumstances will MULTIPANEL be liable for any damages or losses to property damage and personal injury, economic loss or loss of profits, arising from contract or negligence or howsoever arising. Without limiting the foregoing, MULTIPANEL will not be liable for any claims, damages or defects arising or in any way attributable to poor or defective workmanship, poor design and detailing, defective materials, structural movement and/or movement of materials to which the product is attached to, acts of God including but not limiting to severe weather conditions or unusual climate conditions, normal wear and tear, or growth of any organism on the product.

Disclaimer

The recommendations in this literature are based on good building practice, but is not an exhaustive statement of all relevant information as the successful performance of the system depends on several factors outside the control of MULTIPANEL, for example the quality of workmanship and design.

MULTIPANEL



MULTIPANEL Pty Ltd
11 Sonia Street, Carrum Downs
Victoria Australia 3201
Phone +61 3 9787 2544
Fax +61 3 9787 9582
Email info@multipanel.com.au
www.multipanel.com.au